

# STYRO

Sistema decorativo in polistirolo /  
Polystyrene decorative system

**GYPSUM.**





# STYRO

## TIPOLOGIA DI PRODOTTO

Elementi decorativi per interni realizzati in materiale polimerico. In base alla tipologia di prodotto, gli elementi possono essere realizzati in polistirolo estruso, polistirolo espanso, polimero strutturato HD antiurto o poliuretano. Ogni categoria di prodotto è caratterizzata da un alto standard qualitativo della materia prima utilizzata e da una finitura estetica di pregio.

## PRODUCT TYPE

Decorative elements for interiors made of polymeric material. According to product type, the elements can be made in extruded polystyrene, polystyrene foam, impact-resistant HD structured polymer or polyurethane. Each product category is characterized by the high quality of the raw materials and by a high-quality aesthetic finish.



# STYRO

## COLLEZIONE

In questo catalogo sono raccolti i nostri elementi decorativi standard, studiati per realizzare opere decorative in stile classico o contemporaneo, sia su nuovi edifici, sia su edifici in fase di ristrutturazione. Con i nostri prodotti potrete realizzare opere di qualità, durature e di grande effetto con la massima semplicità.

## COLLECTION

This catalog contains our standard decorative elements, designed to create decorative works in classic or contemporary style, both on new buildings and on buildings under renovation. With our products you can create quality, long-lasting and impressive works with the utmost simplicity.

## ARTICOLI / ITEMS

rosoni / ceiling roses

cornici da angolo decorate / ornate cornice mouldings

cornici e angoli per riquadrature / panel mouldings

cornici da angolo lisce / linear cornice mouldings

colonne e pilastri / columns and pilasters

modanature / mouldings

battiscopa / skirting boards

travi decorative / decorative beams

1

2

3

4

5

6

7

STYRO | cornici da angolo lisce in polistirolo estruso /  
linear cornice mouldings in extruded polystyrene

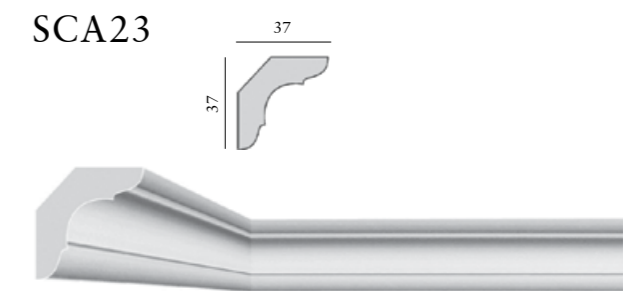
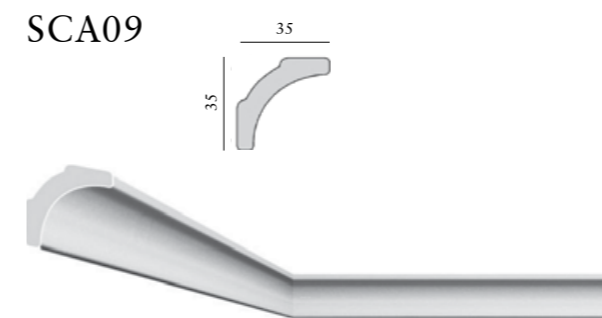
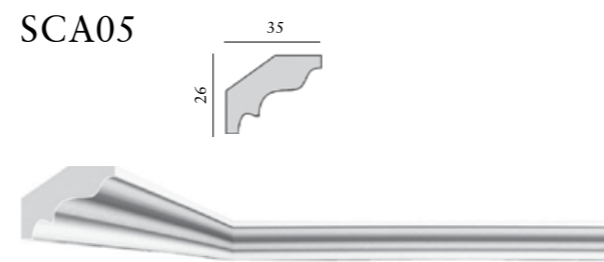
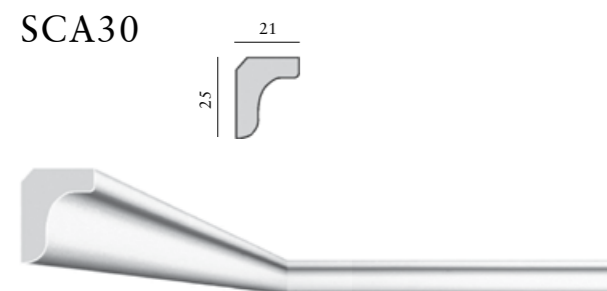
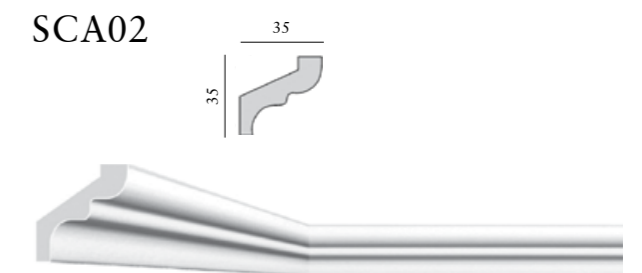
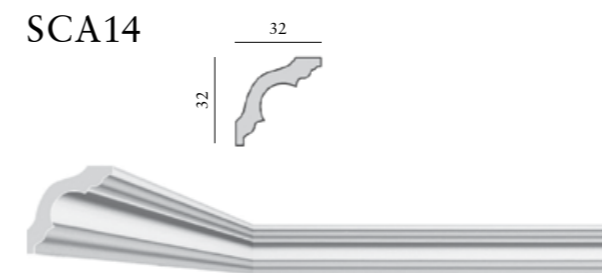
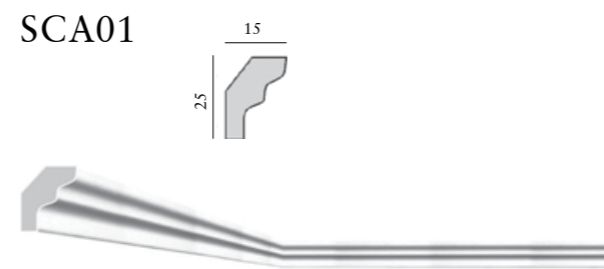
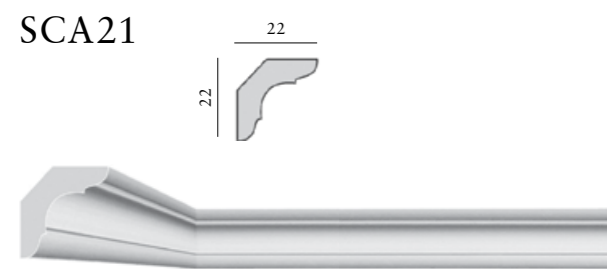
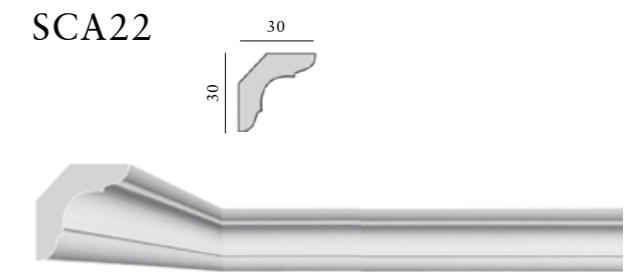
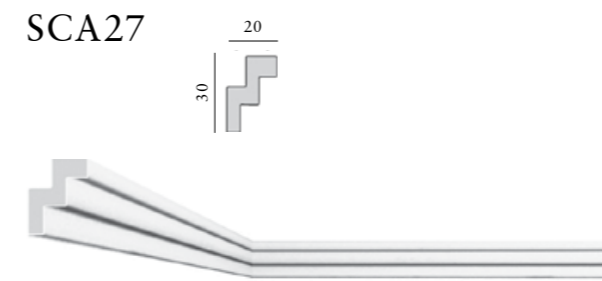
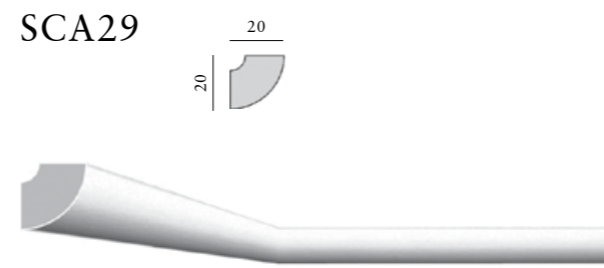
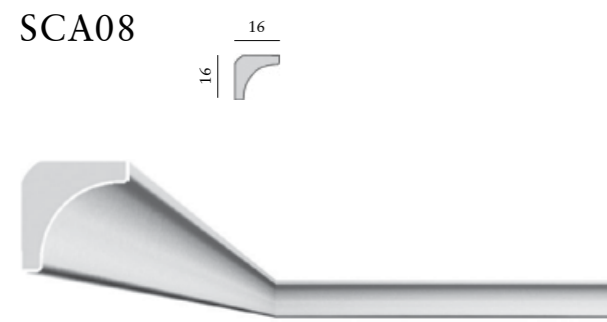

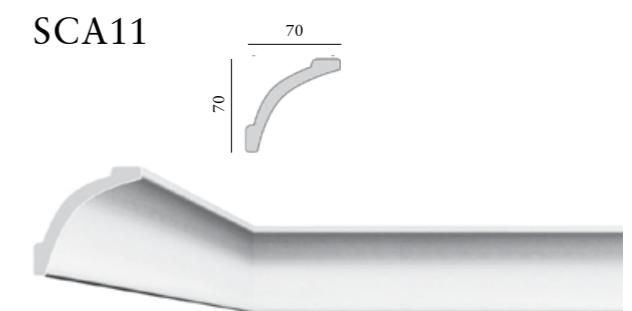
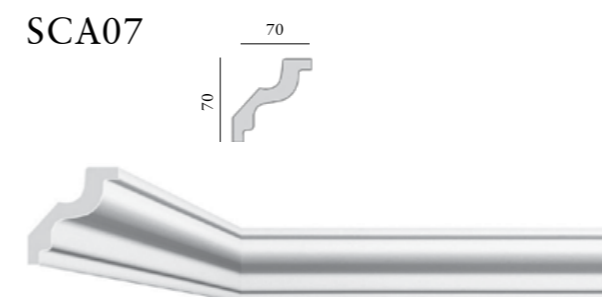
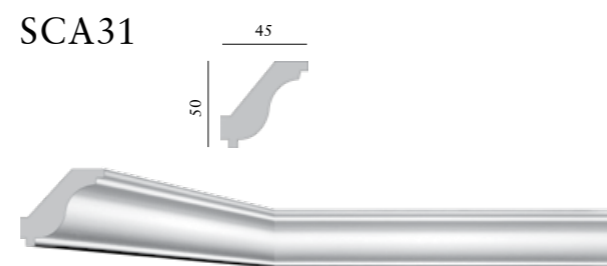
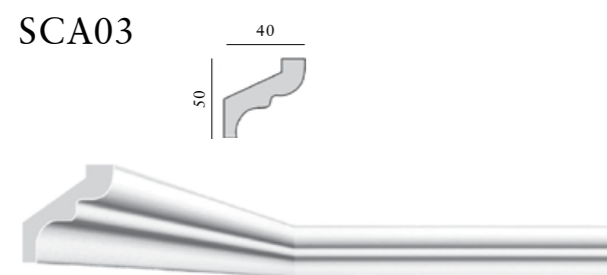
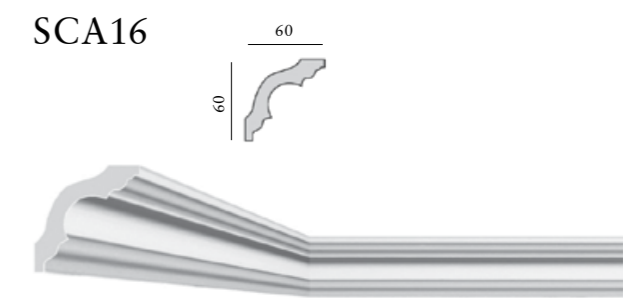
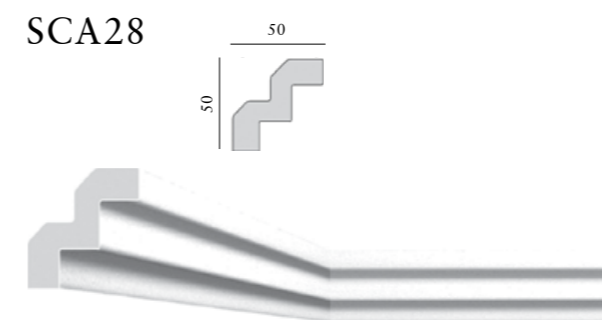
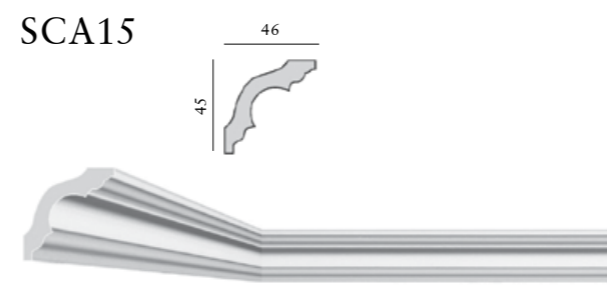
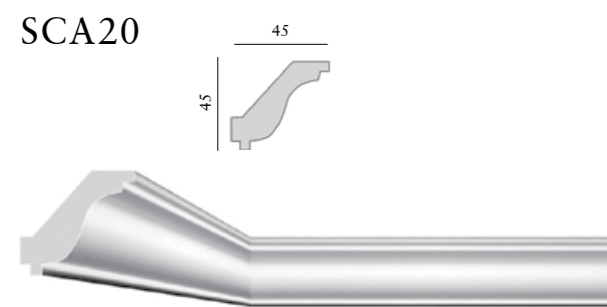
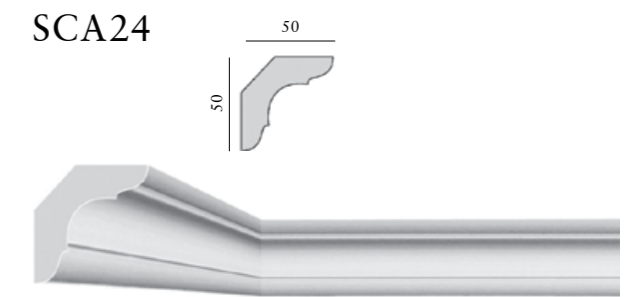
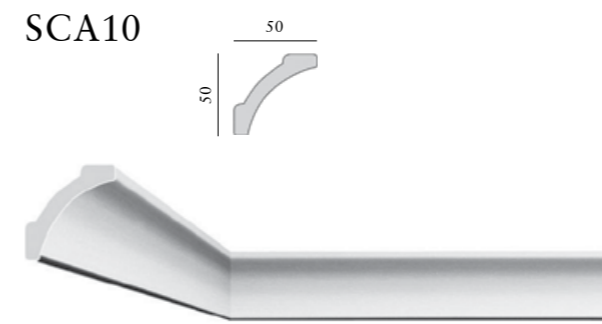
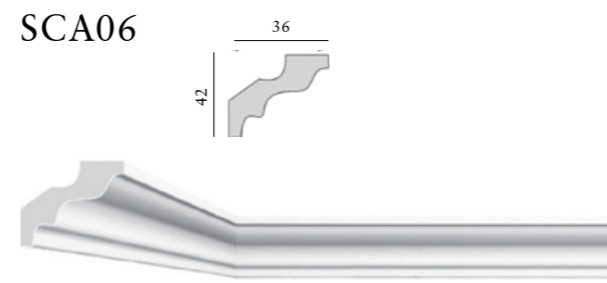
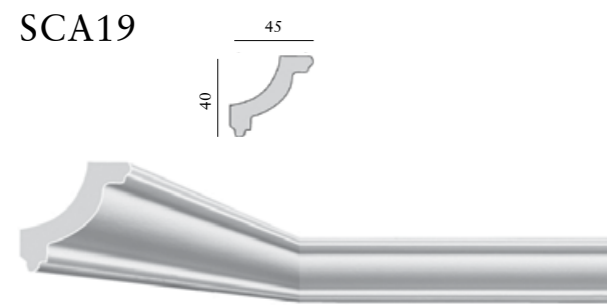

SCA25

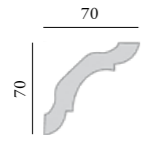

SCA26

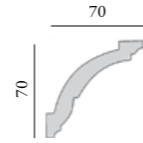

SCA04

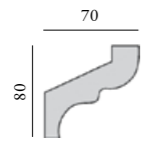

SCA17

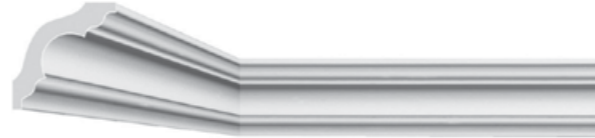
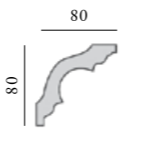

SCA18

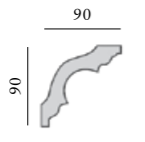

STYRO | cornici da angolo decorate in polistirolo espanso /  
ornate cornice mouldings in polystyrene foam

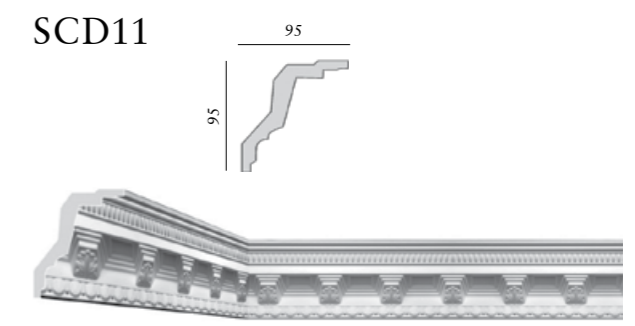
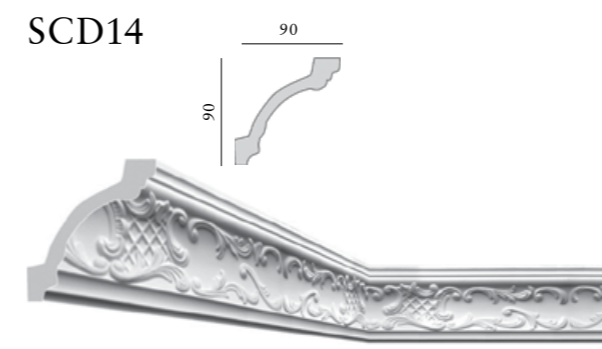
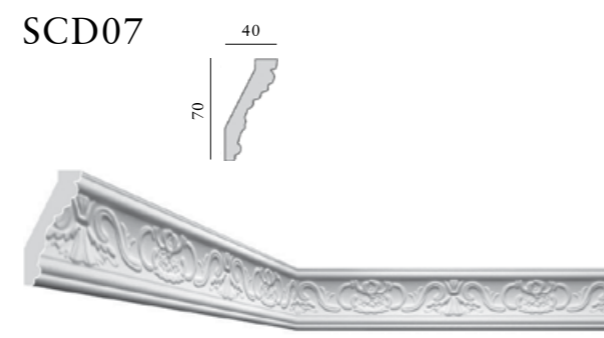
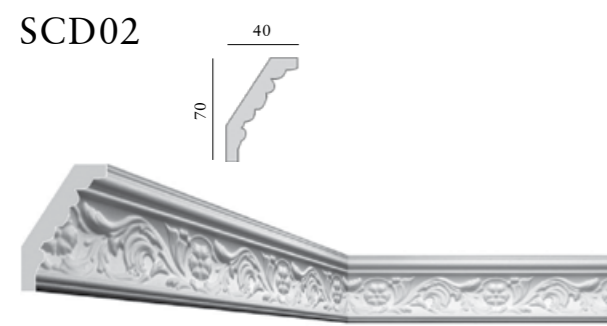
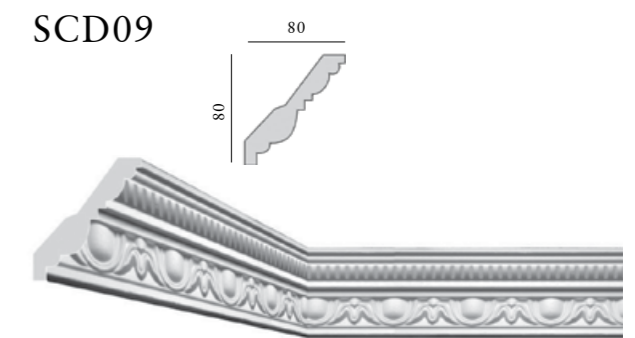
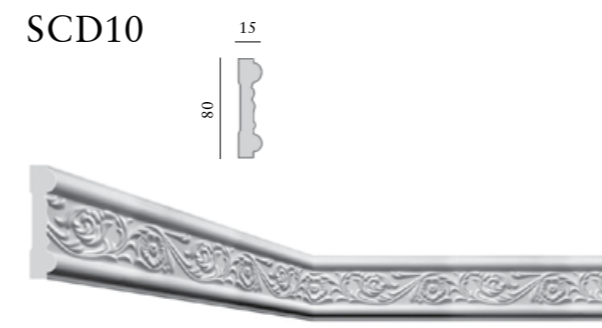
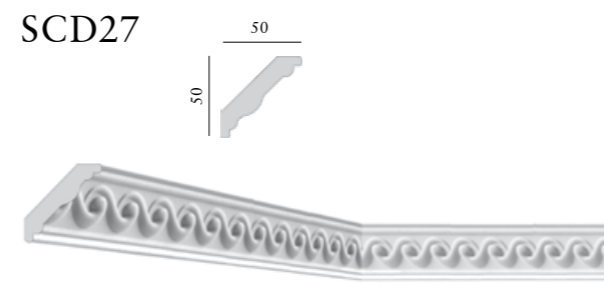
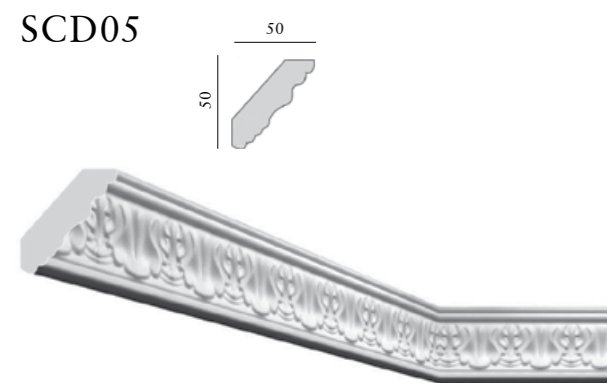
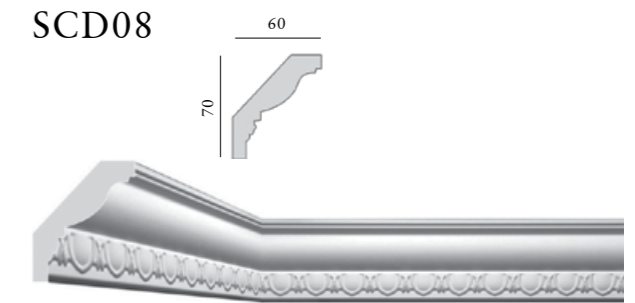
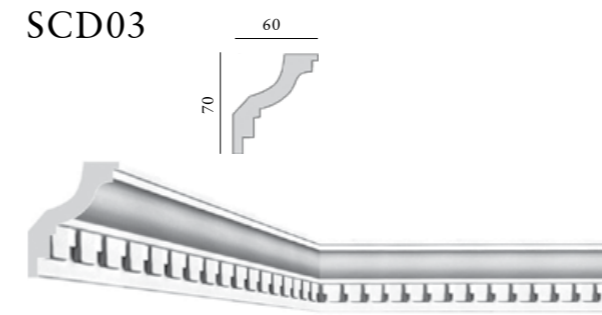
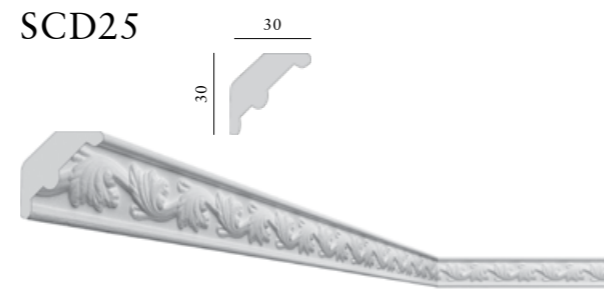
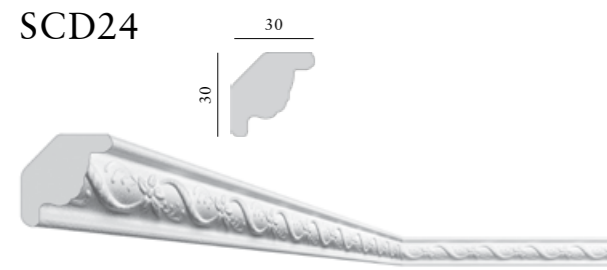



SCD28

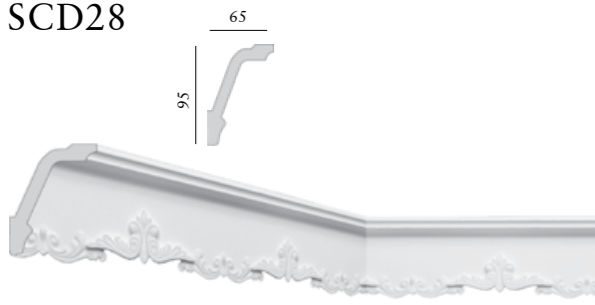

SCD17

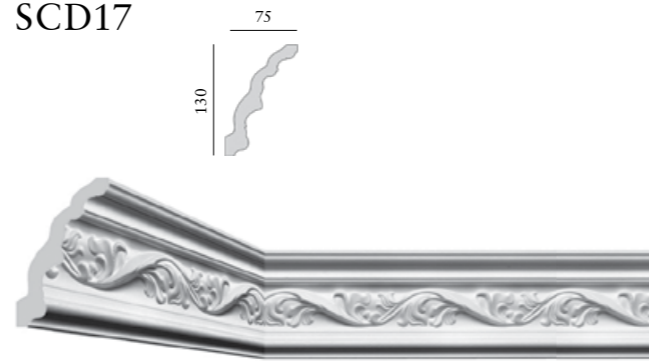

SCD19

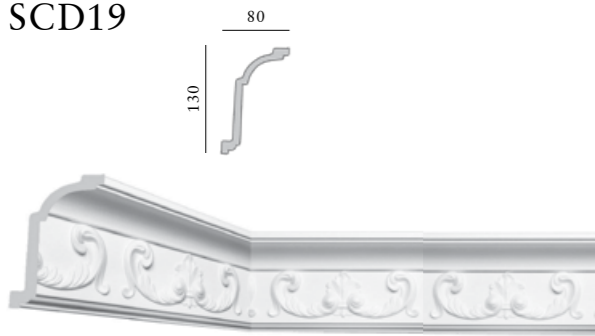

STYRO | cornici per riquadrature ed accessori in polistirolo estruso /  
panel mouldings and accessories in extruded polystyrene

SCR01-A raggio / radius 85 mm



SCR01



SCR03-A raggio / radius 120 mm



SCR03



SCR02-A raggio / radius 120 mm



SCR02



SCR04-A raggio / radius 180 mm



SCR04



SCR02-B L 200 × H 200 mm



SCR02



schema di montaggio /  
assembly diagram



STYRO | modanature, battisedia, battiscopa in polimero strutturato HD /  
mouldings, chair rails, skirtings boards in structured HD polymer

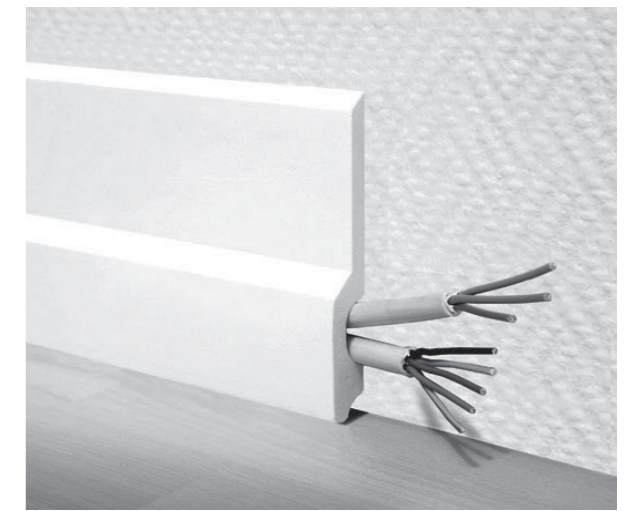
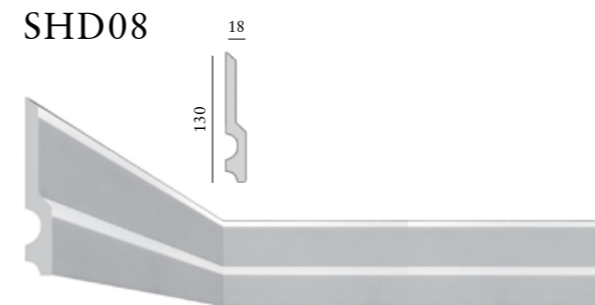
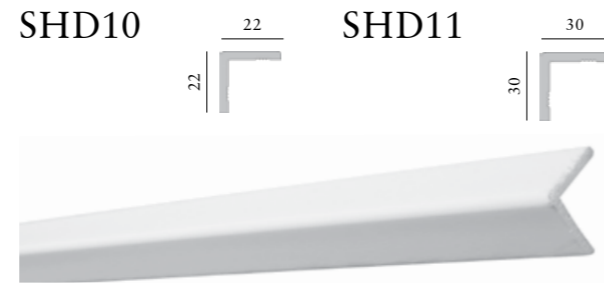
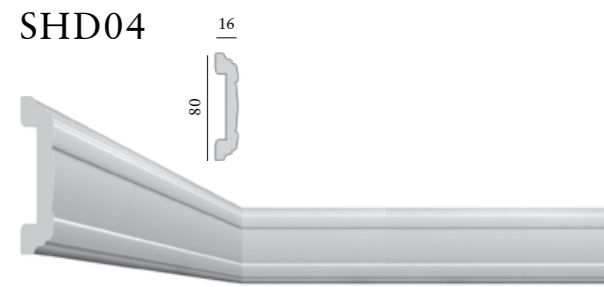
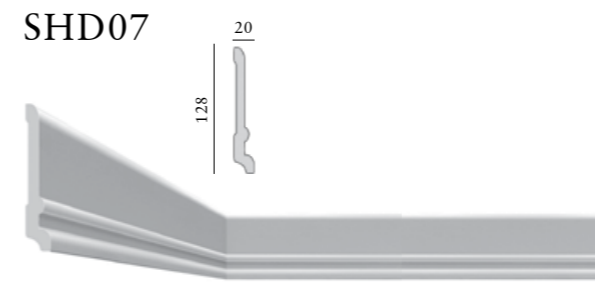
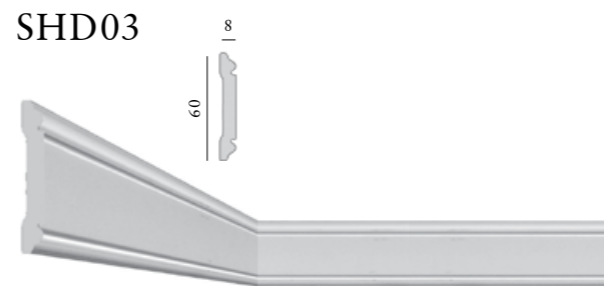
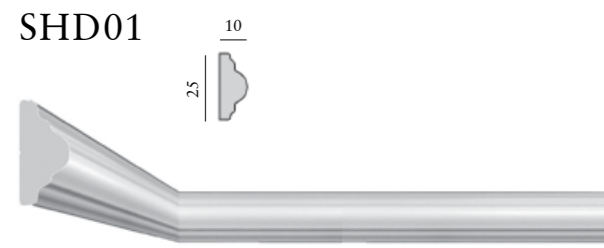
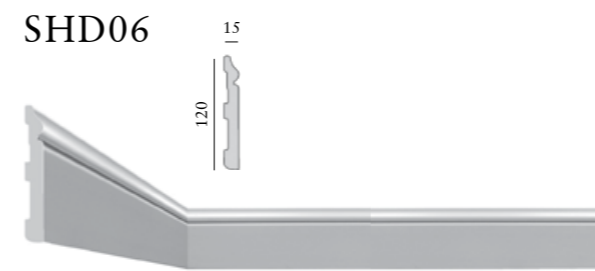
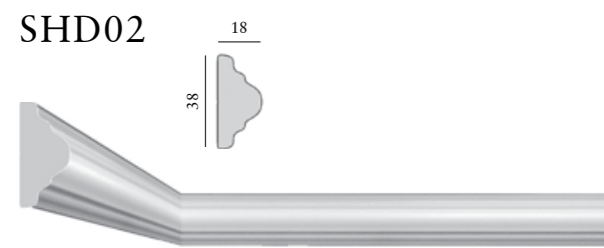
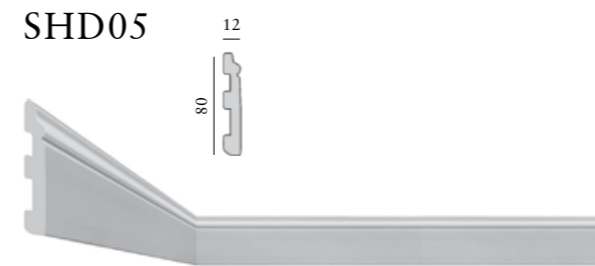
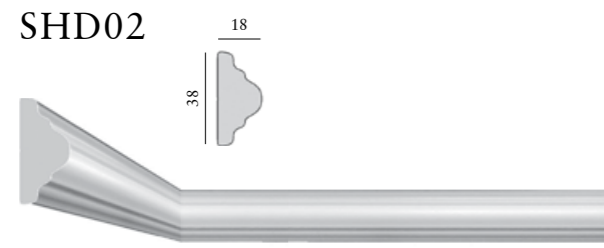

STYRO | rosoni e mensole in polistirolo espanso /  
ceiling roses and corbels in polystyrene foam

SR001 diametro / diameter 280 mm



SR013 diametro / diameter 300 mm



SR005 diametro / diameter 370 mm



SR006 diametro / diameter 370 mm



SR014 diametro / diameter 320 mm



SR015 diametro / diameter 330 mm



SR007 diametro / diameter 370 mm



SR008 diametro / diameter 370 mm



SR016 dimensioni / dimensions 370 x 370 mm

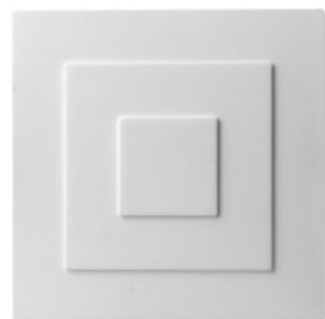

SR017 diametro / diameter 370 mm



SR009 diametro / diameter 370 mm



SR018 diametro / diameter 460 mm



SR010 diametro / diameter 500 mm



SR011 diametro / diameter 520 mm



SR012 diametro / diameter 530 mm



SR019 spessore / thickness 70 mm



SR020 spessore / thickness 100 mm



**STYRO** | colonne e pilastri in polistirolo espanso /  
columns and pilasters in polystyrene foam

KIT COMPLETI /  
COMPLETE KITS

**SP01KIT**  
**SP02KIT**  
**SP03KIT**

1×SPC01 + 1×SPCF02 + 1×SPC02 | altezza / height 2370 mm  
1×SPC01 + 1×SPCF02 + 1×SPB01 | altezza / height 2690 mm  
1×SPC02 + 1×SPCF02 + 1×SPB01 | altezza / height 2760 mm

SP01KIT

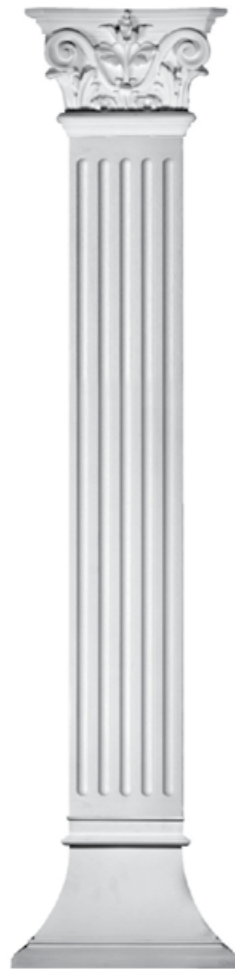

SP02KIT

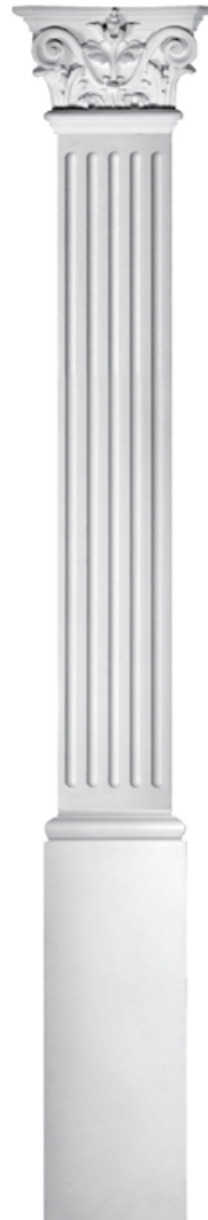

SP03KIT

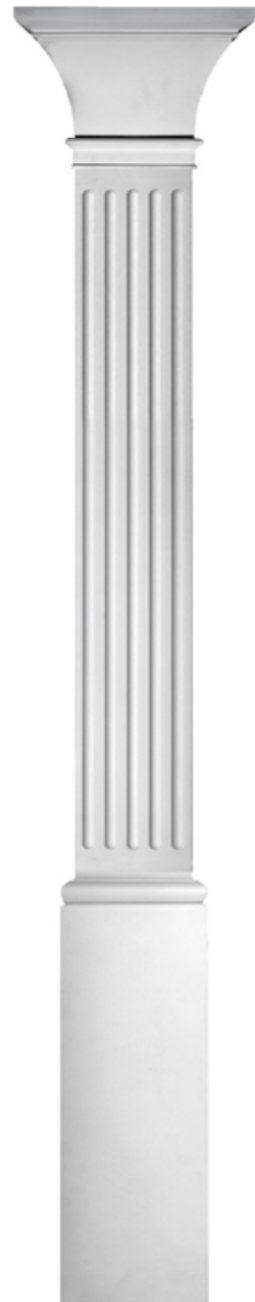

SPC01

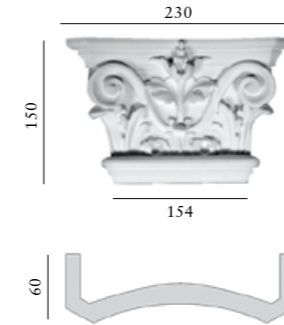

SPC02

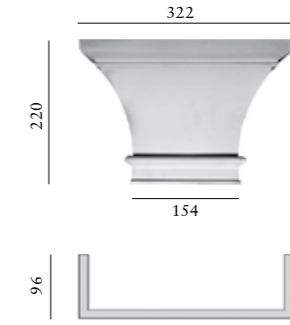

SPCF02

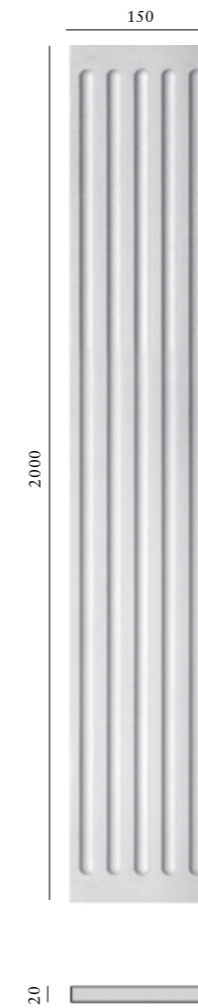

SPB01

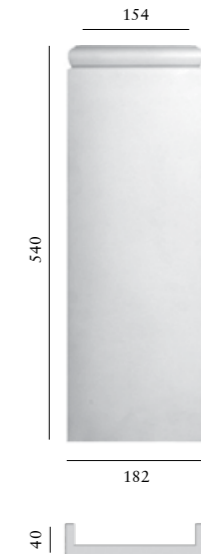

KIT COMPLETI /  
COMPLETE KITS

**SC01KIT** 2×SCC01-H + 2×SCF01-H + 2×SCC03-H | altezza / height 1150 mm  
**SC02KIT** 2×SCC02-H + 2×SCF02-H + 2×SCB01-H | altezza / height 1460 mm  
**SC03KIT** 2×SCC03-H + 4×SCF01-H + 2×SCB01-H | altezza / height 2175 mm  
**SC04KIT** 2×SCC02-H + 6×SCF02-H + 2×SCB01-H | altezza / height 3130 mm

Tutti gli elementi sono compatibili, per questo si possono realizzare anche kit diversi da quelli rappresentati /  
All elements are compatible, therefore kits can also be made other than those shown

SC01KIT



SC02KIT



SC03KIT



SC04KIT



SCC01

fornito in due metà / supplied in two halves  
altezza / height 130 mm

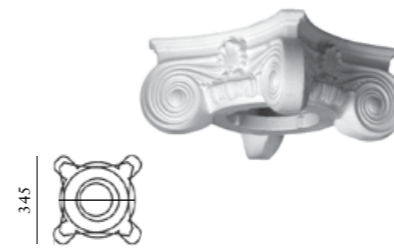

SCC02

fornito in due metà / supplied in two halves  
altezza / height 305 mm



SCC03

fornito in due metà / supplied in two halves  
altezza / height 185 mm



SCB01

fornito in due metà / supplied in two halves  
altezza / height 320 mm

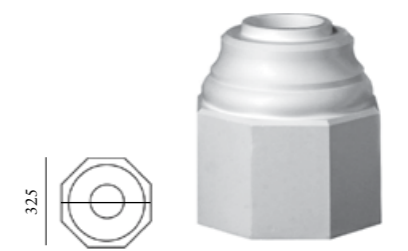

SCF01

fornito in due metà / supplied in two halves  
altezza / height 835 mm  
diametro / diameter 220 mm



SCF02

fornito in due metà / supplied in two halves  
altezza / height 835 mm  
diametro / diameter 220 mm



KIT COMPLETI /  
COMPLETE KITS

**SC05KIT**  
**SC06KIT**

1×SCC02-H + 3×SCF01-H + 1×SCB01-H | altezza / height 3130 mm  
1×SCC03-H + 2×SCF02-H + 1×SCB01-H | altezza / height 2175 mm

Tutti gli elementi sono compatibili, per questo si possono realizzare anche kit diversi da quelli rappresentati /  
All elements are compatible, therefore kits can also be made other than those shown

SC05KIT

SC06KIT



**SCC01-H** altezza / height 130 mm

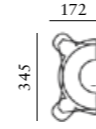

**SCC02-H** altezza / height 305 mm

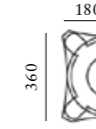

**SCC03-H** altezza / height 185 mm



**SCB01-H** altezza / height 320 mm



**SCF01-H** altezza / height 835 mm  
diametro / diameter 220 mm





**SCF02-H** altezza / height 835 mm  
diametro / diameter 220 mm



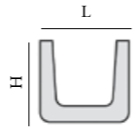

# STYRO | travi decorative e mensole in poliuretano pre-verniciato / decorative beams and corbels in pre-painted polyurethane

TRAVI / BEAMS	STP01	rovere scuro	L 90 × H 60 mm	lunghezza / length 4 m 
	STP02	rovere scuro	L 120 × H 120 mm	
	STP03	rovere scuro	L 200 × H 130 mm	
	STP04	rovere chiaro	L 90 × H 60 mm	
	STP05	rovere chiaro	L 120 × H 120 mm	
	STP06	rovere chiaro	L 200 × H 130 mm	
	STP07	bianco	L 90 × H 60 mm	
	STP08	bianco	L 120 × H 120 mm	
	STP09	bianco	L 200 × H 130 mm	

TAVOLE / BOARDS	STP10	rovere scuro	L 130 × H 30 mm	lunghezza / length 2,6 m 
	STP11	rovere chiaro	L 130 × H 30 mm	
	STP12	bianco	L 130 × H 30 mm	

TRAVE ROVERE SCURO / DARK OAK BEAM



TRAVE ROVERE CHIARO / LIGHT OAK BEAM



TRAVE BIANCA / WHITE BEAM



TAVOLA ROVERE SCURO / DARK OAK BOARD



TAVOLA ROVERE CHIARO / LIGHT OAK BOARD



TAVOLA BIANCA / WHITE BOARD



Abbinare con / Combine with

MENSOLE / CORBELS	STP01-M	rovere scuro	90 × 110 × H 65 mm	STP01
	STP02-M	rovere scuro	120 × 140 × H 95 mm	STP02
	STP03-M	rovere scuro	220 × 200 × H 175 mm	STP03
	STP04-M	rovere chiaro	90 × 110 × H 65 mm	STP04
	STP05-M	rovere chiaro	120 × 140 × H 95 mm	STP05
	STP06-M	rovere chiaro	220 × 200 × H 175 mm	STP06
	STP07-M	bianco	90 × 110 × H 65 mm	STP07
	STP08-M	bianco	120 × 140 × H 95 mm	STP08
	STP09-M	bianco	220 × 200 × H 175 mm	STP09

MENSOLA ROVERE SCURO / DARK OAK CORBEL



MENSOLA ROVERE CHIARO / LIGHT OAK CORBEL



MENSOLA BIANCA / WHITE CORBEL



ACCESSORI / ACCESSORIES	STP13	fascia chiodata / spiked band H 40 × L 1000 mm
	SDT100	accessorio per il corretto taglio a 45° dei profili / accessory for the correct 45° cut of the profiles

STP13



SDT1000

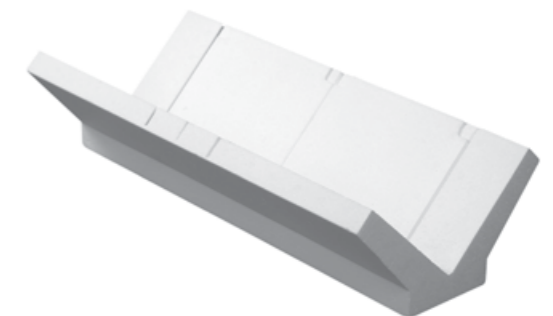

Assistenza tecnica /  
Technical assistance

Offriamo assistenza tecnica nella fase progettuale e forniamo le indicazioni per la corretta posa in opera dei prodotti /  
We offer technical assistance during the design phase and provide indications for the correct installation of the products

Su richiesta /  
Customization

I prodotti del presente catalogo non sono modificabili su richiesta. Nel caso di esigenze particolari o fuori standard, si prega comunque di contattare l'azienda per valutare una soluzione adeguata /  
The products in this catalogue cannot be modified on request. In case of special or non-standard needs, please contact the company to evaluate an appropriate solution

Prodotti e sistemi per la  
corretta posa in opera /  
Products and systems for  
correct installation

La nostra esperienza ci ha permesso di individuare il ciclo di posa ed i materiali più adatti per un risultato finale ottimale, sia da un punto di vista tecnico sia da un punto di vista estetico. Si prega di contattare l'azienda o consultare il sito internet per maggiori dettagli /  
Our long experience allowed us to identify the installation cycle and the most suitable materials for the best final result, both from a technical and an aesthetic point of view. Please contact the company or consult the website for more details

Collaboratori e crediti /  
Contributors and credits

Editore / Editor

Gypsum

Fotografia / Photography

Claudio Tajoli (1, 2, 34-38)

Traduzione / Translation

Chiara Laverone

Stampa / Printing

Tecnostampa S.r.l., Seriate - BG

Aggiornamento / Update

2024

© Gypsum

Tutti i diritti riservati / All rights reserved

Made in Italy

GYP SUM srl

Via C. A. Dalla Chiesa, s.n.

24048 Treviolo BG

Italia

T +39 035 200085

gypsum-arte.com

